

REV. 1

OCEANUS 15 VST

315 - 3 - 5

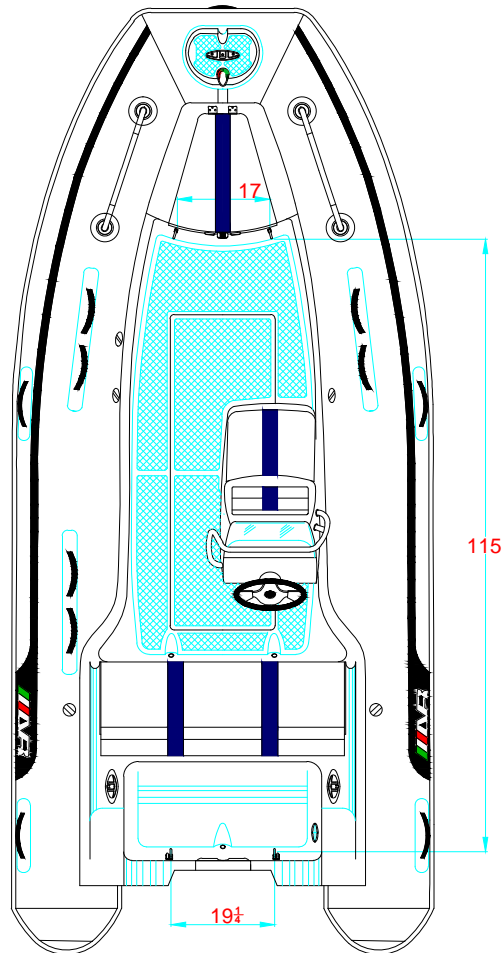

-LOCATION AND DISTANCE
OF DAVIT LIFTING POINTS
UBICACION Y DISTANCIA
DE LOS GANCHOS DE IZADO

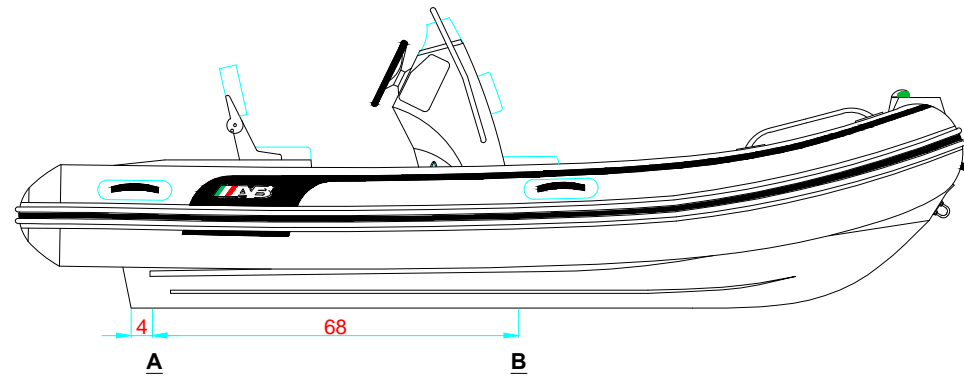

LONGITUDINAL PROFILE
VISTA LATERAL

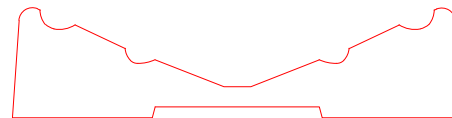

TRANSVERSAL SECTION "A"
SECCION TRANSVERSAL "A"

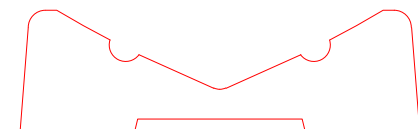

TRANSVERSAL SECTION "B"
SECCION TRANSVERSAL "B"

-RECOMMENDED CHOCK LOCATION AND BUILDING DIMENSIONS
UBICACION DE LAS CUNAS Y SUS MEDIDAS DE FABRICACION

-VERIFY MEASUREMENTS WITH ACTUAL HULL
VERIFICAR MEDIDAS DE ACUERDO A CASCO ACTUAL

NOTES: 1.- ALL DIMENSIONS IN INCHES