

REV. 3

ULTRA 9 UL

320 - 5 - 2

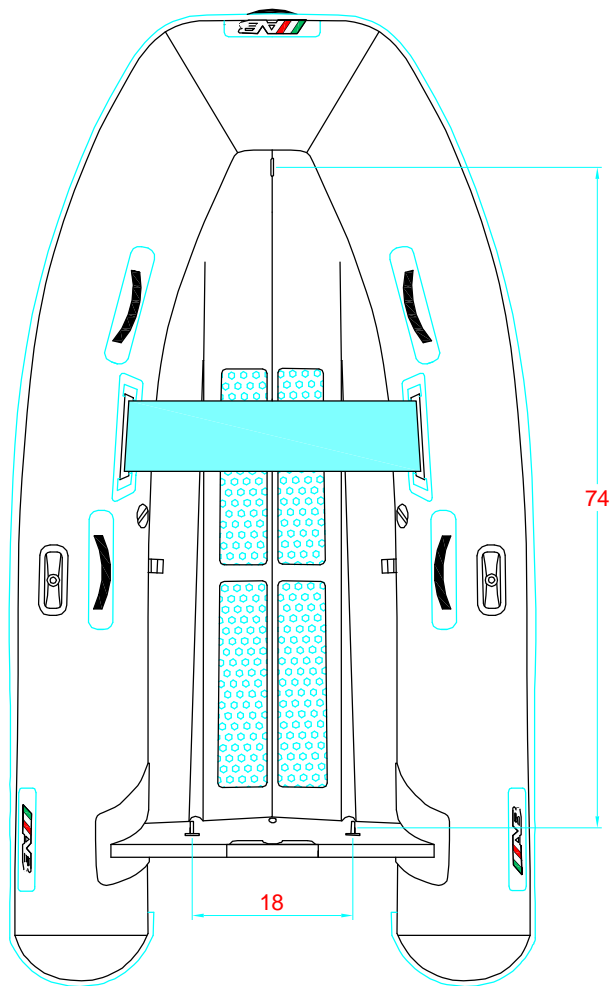

-LOCATION AND DISTANCE
OF DAVIT LIFTING POINTS
UBICACION Y DISTANCIA
DE LOS GANCHOS DE IZADO

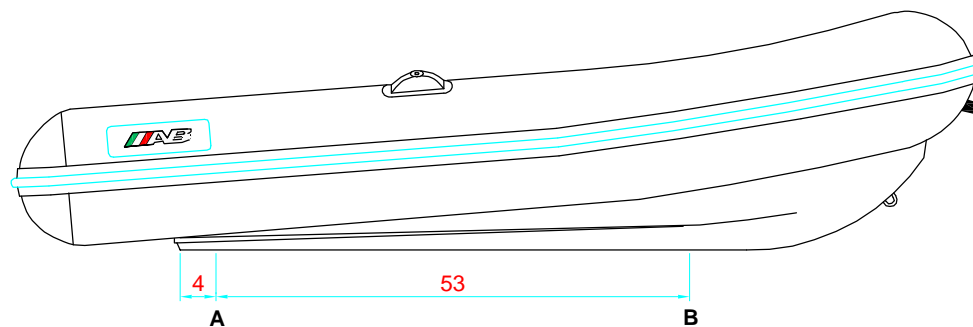

LONGITUDINAL PROFILE
PERFIL LONGITUDINAL

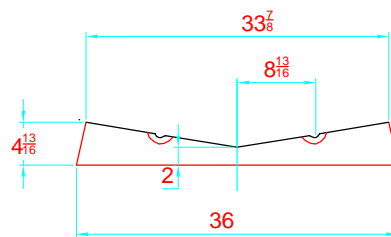

TRANSVERSAL SECTION "A"
SECCION TRANSVERSAL "A"

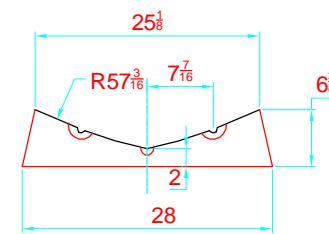

TRANSVERSAL SECTION "B"
SECCION TRANSVERSAL "B"

-RECOMMENDED CHOCK LOCATION AND BUILDING DIMENSIONS
UBICACION DE LAS CUNAS Y SUS MEDIDAS DE FABRICACION

-VERIFY MEASUREMENTS WITH ACTUAL HULL
VERIFICAR MEDIDAS DE ACUERDO A CASCO ACTUAL

NOTES: 1.- ALL DIMENSIONS IN INCHES
2.- MEASURES FROM CENTER OF CHOCK'S SURFACES