

REV. 7

OCEANUS 13 VST

515 - 3 - 3

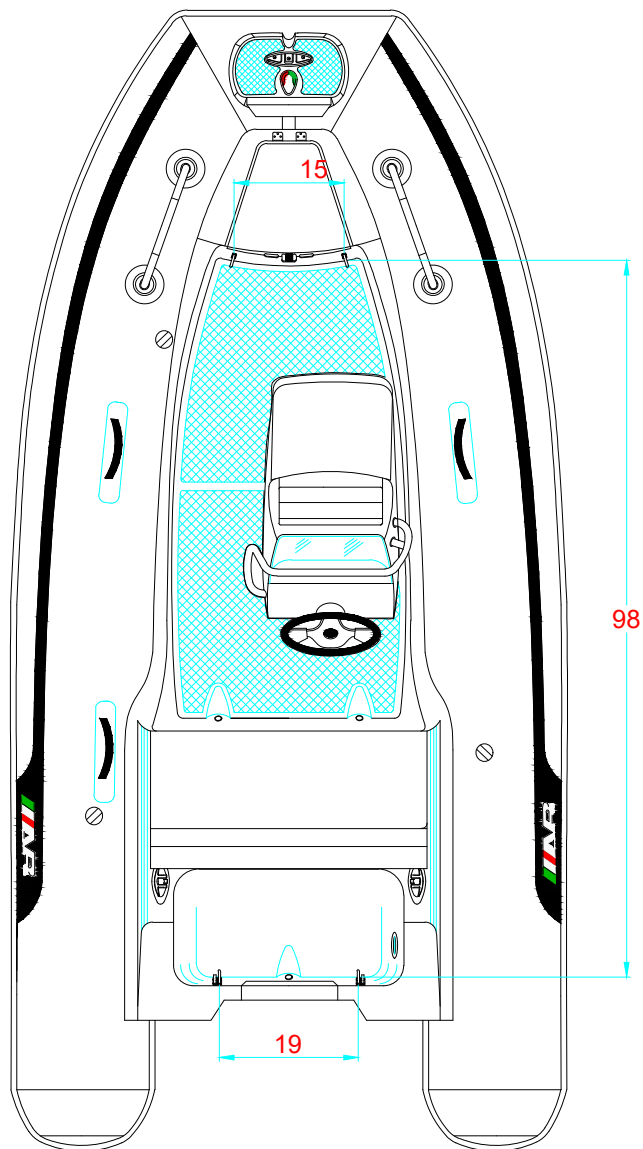

-LOCATION AND DISTANCE
OF DAVIT LIFTING POINTS

UBICACION Y DISTANCIA
DE LOS GANCHOS DE IZADO

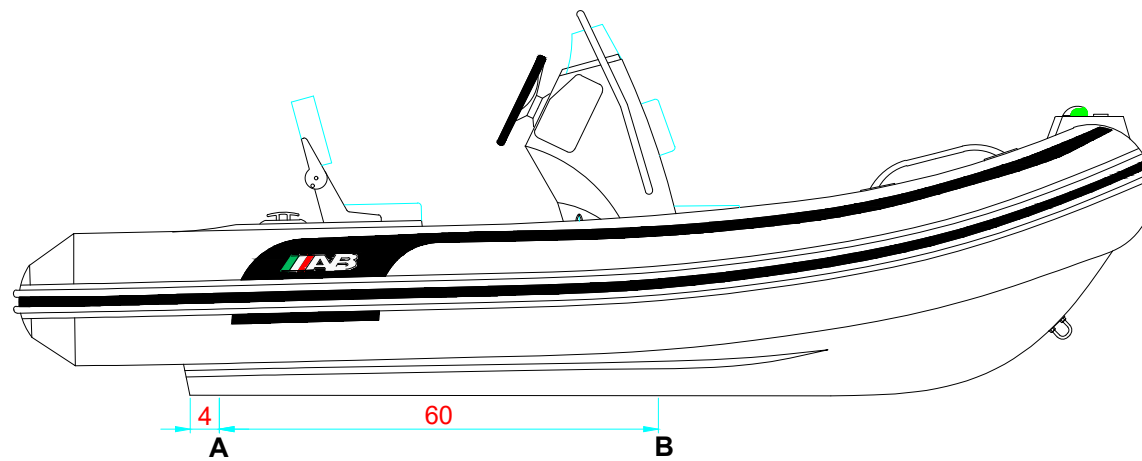

LONGITUDINAL PROFILE
VISTA LATERAL

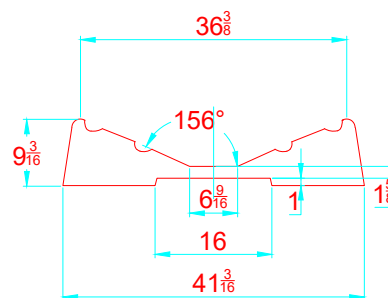

TRANSVERSAL SECTION "A"
SECCION TRANSVERSAL "A"

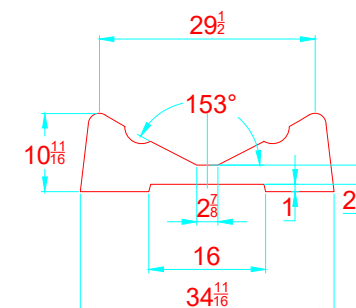

TRANSVERSAL SECTION "B"
SECCION TRANSVERSAL "B"

-RECOMMENDED CHOCK LOCATION AND BUILDING DIMENSIONS
UBICACION DE LAS CUNAS Y SUS MEDIDAS DE FABRICACION

-VERIFY MEASUREMENTS WITH ACTUAL HULL
VERIFICAR MEDIDAS DE ACUERDO A CASCO ACTUAL

- NOTES:**
- 1.- ALL DIMENSIONS IN INCHES
 - 2.- MEASURES FROM CENTER OF CHOCK'S SURFACES